

# VISUAL COOKING K & KPE 1.10



KPE touch model



K standard model

## DIMENSIONS & WEIGHT

Width	899 mm
Height - table model	1055 mm
Height with stand	1492 mm
Depth (excl. handle)	831 mm
Weight	190 kg

## CAPACITY

Tray size	1/1 GN
Number of racks:	
65 mm distance	10
85 mm distance	8
Portions	150

## SPECIFICATIONS, ELECTRIC OVEN

Voltage	3 NAC 400 V
Wattage	18 kW
Current	26 A
Water connection	3/4" outside
Drain	Ø 50 mm outside

## GENERAL FEATURES

- Steam technology: steam generator & injection steam
- Reversible fan ensures perfect baking and cooking results
- Adjustable fan speed with 9 steps
- Optional door hinging, left (standard) or right
- 2-piece rack
- Timer function with current time, date and timer
- Manual humidity pulsing
- Preheating up to 300°C
- 2-step door handle for maximum safety
- CTD Cool Touch Door (max outside temperature of 65°C)
- IP X5 protection
- Cabinet and oven chamber in BS 304 S 31 stainless steel
- Easily detachable door seal
- Indicator of water shortage in steam generator
- AFS Auto Flush System in steam generator
- Various voltages
- Table model prepared for stand

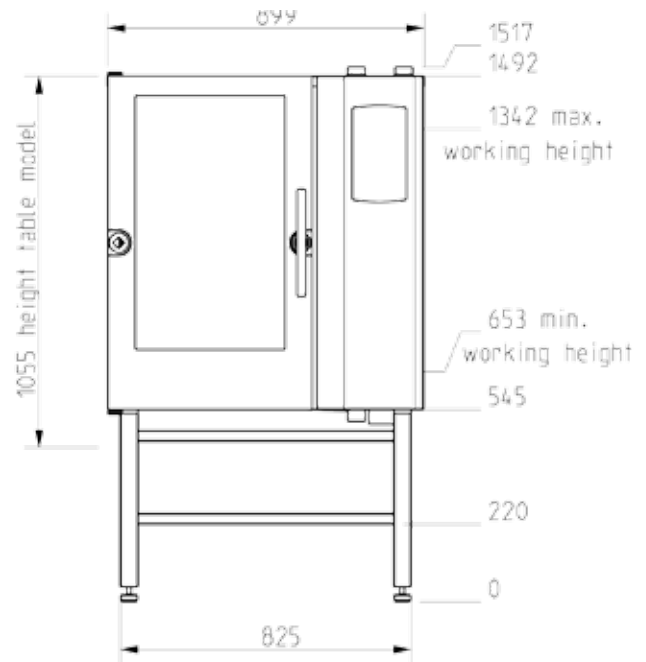

## K COOKING MODES

- Hot air (30-300°C)
- Steaming (30-130°C)
- Low-temperature steaming (30-100°C)
- Forced steaming (130°C)
- CombiSmart® humidity control, 10 steps (30-300°C)
- Cook & Regen (30-180°C)
- Proving (30-40°C)

## KPE COOKING MODES

- Hot air (30-300°C)
- Steaming (30-130°C)
- Low-temperature steaming (30-100°C)
- Forced steaming (130°C)
- ClimaOptima® automatic humidity control (70-300°C)
- CombiSmart® humidity control, 10 steps (30-300°C)
- SmartChef®
- Cook & Regen (30-180°C)
- Proving (30-40°C)
- Delta-T
- Cook & Hold

## K STANDARD FEATURES

- Selection dial and digital display
- Memory of 50 recipes (each with up to 10 steps)
- Semi-automatic cleaning programme
- Automatic cooling
- Error registration

## KPE STANDARD FEATURES

- SmartTouch® display
- Memory of 500 recipes (each with up to 15 steps)
- Cookbook with preset programmes
- CombiWash® fully automatic cleaning system
- Integrated hand shower
- Manual or automatic cooling
- Automatic humidity pulsing
- Core temperature probe, external location
- RackTimer®
- CombiNet®
- HACCP quality control
- USB connection
- Automatic service diagnosis system

## ACCESSORIES

- CombiWash® fully automatic cleaning system (K)
- Integrated hand shower (K)
- Core temperature probe, external location (K)
- Sous-vide probe (KPE)
- Removable cassette rack or rack for plates
- Trolley for racks
- Various stands
- Energy & water consumption meter (KPE)
- 2-door solution (PassThrough)
- Stacking kit for CombiPlus®



HOUNÖ A/S  
Alsvej 1  
DK-8940 Randers SV  
Denmark  
T: +45 8711 4711  
E: houno@houno.com  
[www.houno.com](http://www.houno.com)